

1200 ISO

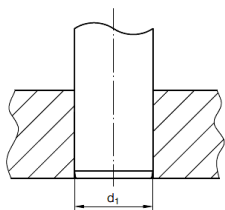

d1	D
10-11-12	-0,015 -0,025
15-16	
19-20	
24-25	
30-32	
38-40	
48-50	
60-63	

1205 ISO

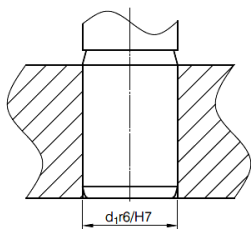

d1	D
25	+0,0021 0
32	+0,0025 0
40	
50	
63	+0,0030 0
80	+0,035 0
100	
125	
160	+0,040 0

1210 ISO

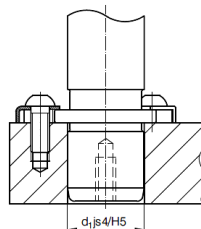

d1	D
15-16	+0,008 0
19-20	+0,009 0
24-25	+0,009 0
30-32	+0,011 0
38-40	+0,011 0
48-50	+0,013 0
60-63	+0,013 0
80	+0,013 0

1215 ISO

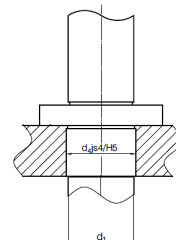

d1	d4	D
12	13	+0,008 0
16	18	+0,008 0
19	22	+0,009 0
25	26	+0,009 0
32	34	+0,011 0
40	42	+0,011 0

1200 ISO/1240 ISO/ 1250 ISO

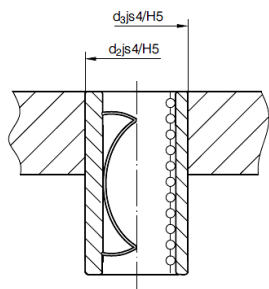

1231._ISO/1241._ISO/ 1251._ISO

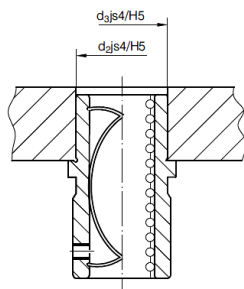

1232._ISO/1242._ISO/ 1252._ISO

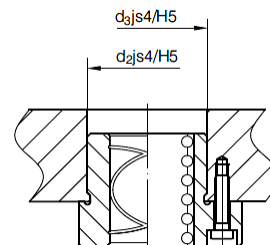

d1	10-11-12	15-16	19-20	24-25	30-32	38-40	48-50	60-63	80
d2	22	28	32	40	48	58	70	85	95,7/105
d3	22/26	28	32	40	48	58	70	85	105
	+0,009 0	+0,009 0	+0,011 0	+0,011 0	+0,011 0	+0,013 0	+0,013 0	+0,015 0	+0,015 0

1270/1270.1

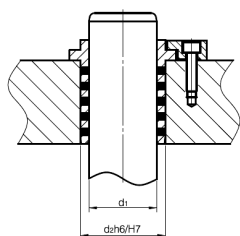

d1	d2	D
24/25	32-35	+0,025 0
30/32	40-42	
38/40/42	50	
48/50/52	63	+0,03 0
60-63	80	
80	100	+0,035 0
100	125	+0,004 0
125	160	+0,046 0
160	200	

1271

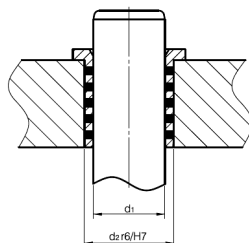

d1	d2	D
10-12	14-18	+0,018 0
13-20	19-30	+0,021 0
25-40	35-50	+0,025 0
45-63	55-75	+0,030 0
70-100	85-120	+0,035 0
120	140	+0,040 0

1272/1272.1/1272.2

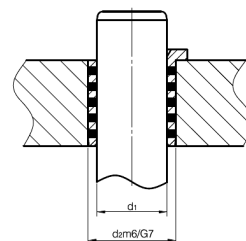

d1	d2	D
8-12	12-18	+0,024 +0,006
13-20	19-30	+0,028 +0,007
25-40	33-50	+0,034 +0,009
40-65	55-80	+0,04 +0,01
70-100	85-120	+0,047 +0,012
110-160	130-180	+0,054 +0,014

1273

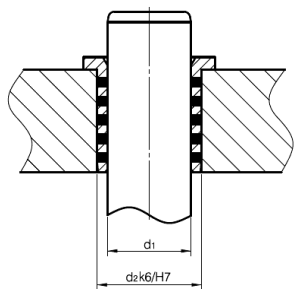

d1	d2	D
9/10	14	+0,018 0
14/15	20	+0,025 0
18/20	26	
22/24	30	
30/32	42	+0,025 0
40/42	54	+0,03 0

1274/1274.1

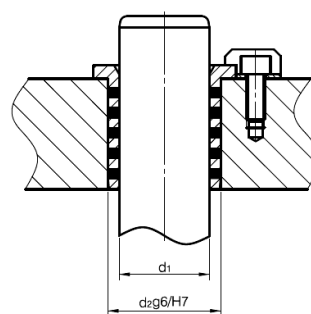

d1	d2	D
25/32/40	32-35	+0,018 0
50/63	63	+0,025 0
80	100	+0,025 0
100/125	125/160	+0,025 0