

POWER TOOLS

KERN FØRINGSSØJLE M. CENTERING

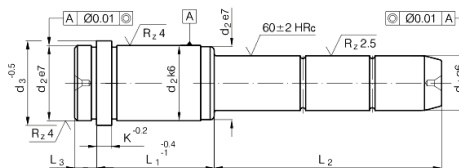

Mat.: 1.7131

Bestillingsnr. 2200 H-d₁ x L₁ x L₂

d1	L1	L2	L3	K	d2	d3	Pris
9/10	12	25	3	3	14	16	
		45					
		65					
	17	20					
		30					
		50					
		70					
	22	25					
		35					
		55					
		75					
	27	95					
		20					
		30					
		50					
	36	70					
		90					
		25					
		45					
	46	65					
85							
30							
45							
56	70						
	35						
	60						
14/15	17	35	9	6	20	25	
		55					
		75					
		95					
	22	30					
		50					
		70					
		90					
		110					
		125					
		150					

d1	L1	L2	L3	K	d2	d3	Pris	
14/15	27	30	9	6	20	25		
		45						
		65						
		85						
		105						
		125						
		145						
		165						
		36					35	
							55	
	75							
	95							
	125							
	155							
	46	35						
		45						
		65						
		85						
		105						
		125						
		145						
		135						
	56	55						
		65						
		95						
		125						
95								
75								
66	55							
	65							
	95							
	125							
	95							
	75							
76	55							
	95							
	55							
	95							
86	55							
	95							
	55							
96	55							
	95							
116	75							

POWER TOOLS

KERN

**FØRINGSSØJLE
M. CENTERING**

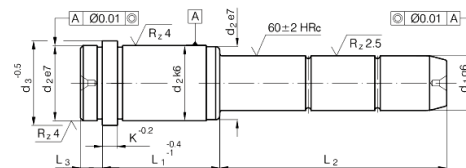

Mat.: 1.7131

Bestillings nr. 2200 H-d₁ x L₁ x L₂

d1	L1	L2	L3	K	d2	d3	Pris
18/20	17	35	9	6	26	31	
		55					
		75					
		120					
	22	35					
		45					
		65					
		85					
		115					
	27	35					
		45					
		65					
		85					
		105					
		125					
		165					
	36	225					
		245					
		35					
		55					
		75					
		95					
		115					
	46	135					
		165					
		225					
		255					
		35					
45							
65							
56	85						
	105						
	135						
	165						
	245						

d1	L1	L2	L3	K	d2	d3	Pris
18/20	56	55	9	6	26	31	
		75					
		95					
		155					
		35					
	66	55					
		75					
		95					
		145					
	76	55					
		75					
		95					
		135					
		55					
86	75						
	95						
	125						
	55						
96	95						
	115						
	135						
	55						
22/24	17	75	9	6	26	31	
		55					
	22	35					
		55					
		75					
		105					
	27	130					
		35					
		45					
		65					
56	85						
	105						
	125						
	35						

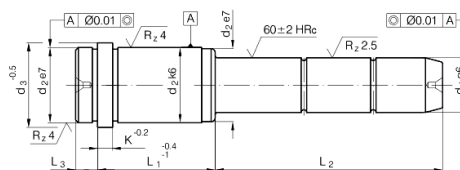

Mat.: 1.7131

Bestillingsnr. 2200 H-d₁ x L₁ x L₂

d1	L1	L2	L3	K	d2	d3	Pris	
22/24	27	165	9	6	30	35		
		205						
		245						
		285						
	36	35						
		55						
		75						
		95						
		115						
		135						
		165						
		205						
		245						
		285						
		46					35	
							45	
	65							
	85							
	105							
	125							
	165							
	205							
	56	35						
		55						
		75						
		95						
		115						
		165						
66	35							
	55							
	75							
	95							
76	55							
	75							

d1	L1	L2	L3	K	d2	d3	Pris
22/24	76	95	9	6	30	35	
		115					
		145					
	86	55					
		75					
		95					
		135					
		155					
	96	55					
		75					
		95					
		125					
		155					
	116	115					
		155					
		135					
155							
30/32	27	45	42	47	30	35	
		65					
		105					
		165					
		185					
		245					
	36	55					
		75					
		95					
		115					
		155					
		245					
46	45						
	65						
	85						
	105						
	125						

POWER TOOLS

KERN

**FØRINGSSØJLE
M. CENTERING**

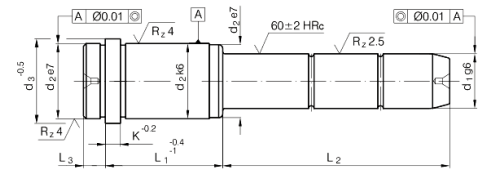

Bestillingsnr. 2200 H-d₁ x L₁ x L₂

Mat.: 1.7131

d1	L1	L2	L3	K	d2	d3	Pris
30/32	46	165	9	6		47	
		245					
		285					
	56	55					
		75					
		95					
		115					
		135					
		175					
		245					
		295					
		66					55
	75						
	95						
	115						
	135						
	175						
	245						
	295						
	76						55
		75					
		95					
		115					
		155					
		225					
	86	55					
		75					
		95					
		115					
		155					
		225					
	96	55					
75							
95							
115							
155							
116	75						
	115						

d1	L1	L2	L3	K	d2	d3	Pris
30/32	116	155	9	6	42	47	
		95					
	136	115					
		155					
	156	115					
		155					
196	155						
	195						
40/42	46	95	12	10	54	60	
		165					
	56	75					
		115					
		155					
	66	195					
		75					
		135					
	76	75					
		115					
		175					
	86	75					
		135					
	96	75					
		115					
		155					
		195					
	116	135					
		195					
		95					
136	95						
	135						
	215						
156	115						
	155						
196	215						
	155						
	195						
246	235						
	165						
		245					

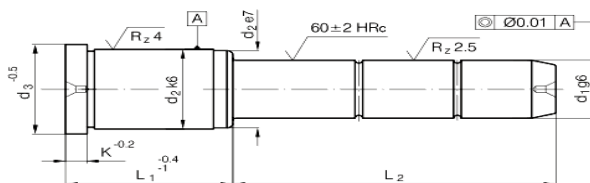

Bestillingsnr. 2210 H-d₁ x L₁ x L₂

d ₁	L ₁	L ₂	K	d ₂	d ₃	Pris	
9/10	17	20	3	14	16		
		30					
	22	25					
		35					
		55					
	27	30					
		50					
	36	25					
		45					
	46	30					
		45					
	14/15	22				20	6
35							
40							
45							
50							
55							
65							
70							
90							
110							
27			20				
			35				
		40					
		45					
		55					
		65					
		85					
		105					
		36	20				
			35				
			40				
			45				
55							
65							
75							
95							
46			20				
			35				
			45				
			65				
		85					
		105					
		56	20				
			35				

d ₁	L ₁	L ₂	K	d ₂	d ₃	Pris				
14/15	56	55	6	20	25					
		75								
		95								
	66	55								
		65								
		95								
	76	55								
		95								
	86	55								
		95								
	18/20	22				20	6	26	31	
						35				
40										
45										
50										
55										
60										
65										
70										
80										
85										
115										
27		20								
		35								
		40								
		45								
		50								
		55								
		60								
		65								
		70								
		80								
		85								
		105								
125										
36		20								
		35								
		40								
		45								
		50								
		55								
		60								
		65								
		70								
		75								

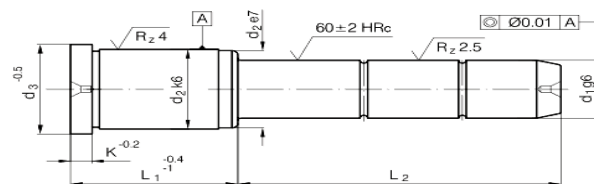

Bestillingsnr. 2210 H-d1 x L1 x L2

d1	L1	L2	K	d2	d3	Pris	d1	L1	L2	K	d2	d3	Pris
18/20	36	80	6	26	31		22/24	36	75	6	30	35	
		95				80							
		115				95							
		135				115							
	46	20				135							
		45				165							
		65				25							
		85				45							
		105				50							
		135				60							
	56	165				65							
		20				70							
		35				80							
		55				85							
	66	75				105							
		95				125							
		165				165							
	76	55				25							
		75				45							
		95				55							
115		75											
86	75	95											
	95	115											
	165	165											
	55	55											
96	75	55											
	95	75											
	115	95											
	165	165											
22/24	27	25	30	35	35		76	25	6	30	35		
		45				45							
		50				55							
		60				75							
		65				95							
		70				115							
		80				55							
		85				75							
	105	95											
	36	125				55							
		165				75							
		25				95							
		45				115							
		50				155							
		55				165							
		60				75							
70		95											
30/32	27	45								42	47		
		65											

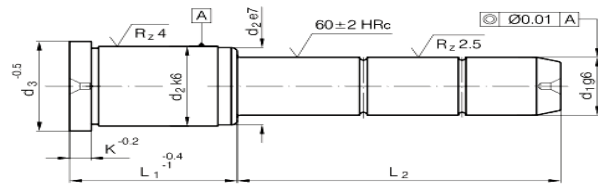

Bestillings nr. 2210 H-d1 x L1 x L2

d1	L1	L2	K	d2	d3	Pris
30/32	27	105	6	42	47	
		165				
	36	55				
		75				
		95				
		115				
		155				
	46	45				
		65				
		85				
		105				
		125				
	56	165				
		55				
		75				
		95				
		115				
	66	135				
		175				
		55				
		75				
		95				
	76	115				
		155				
		55				
		75				
		95				
	86	115				
		155				
		55				
		75				
	96	95				
		115				
		155				
		75				
	116	115				
155						
136	95					

d1	L1	L2	K	d2	d3	Pris
30/32	136	115	6	42	47	
		155				
	156					
40/42	196	115	10	54	60	
		155				
		195				
	56	75				
		115				
		155				
	66	195				
		75				
	76	135				
		75				
	86	175				
		115				
		135				
	96	135				
		115				
155						
116	135					
	195					
	95					
136	215					
	115					
	155					
156	155					
	215					
	155					
196	195					
	235					
	95					
50/52	115					
	135					
	135					
	155					
60/62	175					
	96					
	115					
	135					
66	135					
	155					
	175					
	195					
72	115					
	135					
	135					
	155					
86	175					
	155					
	175					
	195					

POWER TOOLS

KERN SKRÅSØJLER

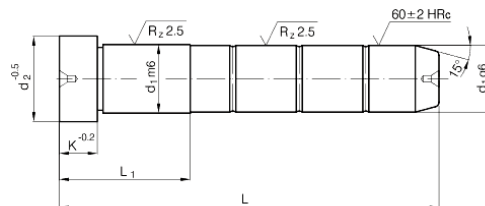

Bestillingsnr. 2221 H-d₁ x L

d ₁	L	K	L ₁	d ₂	Pris
10	40	3	17	12	
	60		22		
	80		27		
12	60	6	17	16	
	80		22		
	100		27		
14	60	8	17	18	
	80		22		
	100		27		
	140		36		
	160		36		
16	60	8	17	20	
	80		22		
	100		27		
	120		36		
	140		36		
18	80	8	22	22	
	100		27		
	120		36		
	140		46		
	160		56		
	180		56		
20	80	8	22	24	
	100		27		
	120		36		
	140		36		

d ₁	L	K	L ₁	d ₂	Pris
20	180	8	56	24	
	200		56		
22	100	15	27	26	
	120		36		
	140		46		
	160		56		
	180		56		
	200		56		
24	100	15	27	28	
	120		36		
	140		46		
	160		56		
	180		56		
30	160	15	36	36	
	200		56		
	240		56		
32	160	15	36	36	
	200		56		
40	200	15	56	48	
	240		56		
	300		56		
50	200	15	46	58	
	240		56		
60	240	20	56	68	
	300		76		
	360		76		

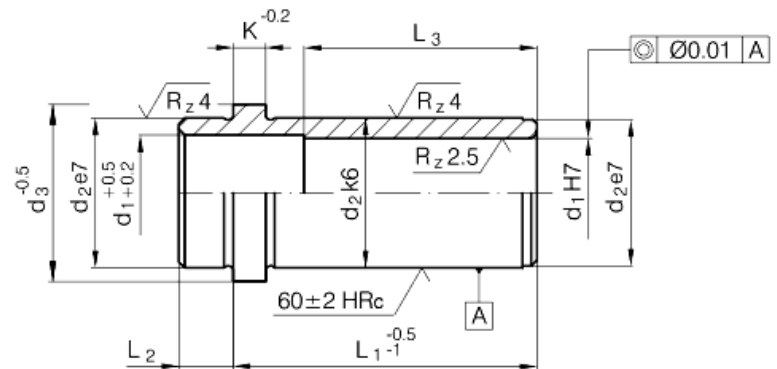

Bestillingsnr.: 2230 H d1 x L1

d1	L1	L2	L3	K	d2	d3	Pris	
9/10	12	3	-	3	14	16		
	17							
	22							
	27							
	36							
	46						36	
	56							
14/15	17	9	-	6	20	25		
	22							
	27							
	36							
	46							
	56						46	
	66							
	76							
	86							
	96							
18/20	116	9	-	6	26	31		
	17							
	22							
	27							
	36							
	46							
	56						56	
	66							
	76							
	86							
22/24	96	9	-	6	30	35		
	116							
	136							
	17							
	22							

d1	L1	L2	L3	K	d2	d3	Pris	
22/24	36	9	-	6	42	47		
	46							
	56							
	66							
	76							
	86						76	
	96							
	116							
	136							
	156							
30/32	27	9	-	6	42	47		
	36							
	46							
	56							
	66							
	76							
	86							
	96							
	116						96	
	136							
40/42	156	12	-	10	54	60		
	196							
	36							
	46							
	56							
	66							
	76							
	86							
	96							
	116						116	
136								
246								

POWER TOOLS

KERN FØRINGSBØSNING M. CENTRERING/BRONZE GRAFIT

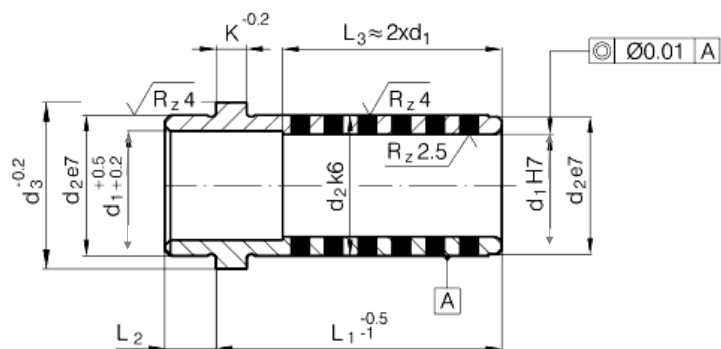

Bestillingsnr.: 2231 H d_1 x L_1

d1	L1	L2	K	d2	d3	Pris	
9/10	12	3	3	14	16		
	17						
	22						
	27						
	36						
	46						
	56						
14/15	17	9	6	20	25		
	22						
	27						
	36						
	46						
	56						
	66						
18/20	17			26	31		
	22						
	27						
	36						
	46						
	56						
	66						
22/24	22	30	35				
	27						
	36						

d1	L1	L2	K	d2	d3	Pris		
22/24	46	9	6	30	35			
	56							
	66							
	76							
	86							
	96							
	116							
30/32	27			42	47			
	36							
	46							
	56							
	66							
	76							
	86							
40/42	96	54	60					
	116							
	136							
	156							
	176							
	196							
	216							

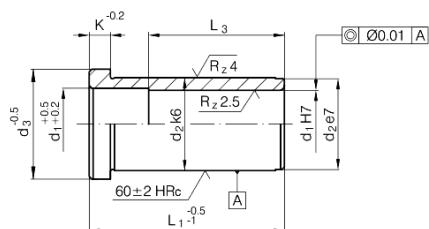

Bestillingsnr.: 2240 H d₁ x L₁

d1	L1	L3	K	d2	d3	Pris	
9/10	9	-	3	14	16		
	12						
	17						
	22						
	27						
	36						
	46					36	
	56						
	66						
12	17	-	6	18	23		
	22						
	27						
	36					36	
	46						
56							
14/15	12	-	6	20	25		
	27						
	22						
	27						
	36						
	46					46	
	56						
	66						
	76						
86							
96							
16	17	-	6	22	27		
	22						
	27						
	36						
	46						
	56						
18/20	17	-	6	26	31		
	22						
	27						
	36						
	46						
	56					56	
	66						
	76						
	86						
96							
116							
22/24	17	-	6	30	35		
	22						

d1	L1	L3	K	d2	d3	Pris	
22/24	27	-	6	30	35		
	36						
	46						
	56						
	66					76	
	76						
	86						
	96						
	116						
	136						
30/32	27	-	6	42	47		
	36						
	46						
	56						
	66					96	
	76						
	86						
	96						
116							
136							
156							
40/42	46	-	10	54	60		
	56						
	66						
	76						
	86						
	96					116	
	116						
	136						
	156						
	196						
246							
50/52	76	-	10	66	72		
	96						
	116					116	
	136						
	156						
	196						
60/62	96	-	20	80	86		
	116						
	136					136	
	156						
	196						
	246						

POWER TOOLS

KERN FØRINGSBØSNING BRONZE GRAFIT

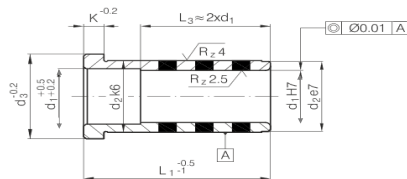

Bestillingsnr.: 2241 d1 x L1

Mat.: CuZn25Al5Mn4Fe3-C

d1	L1	K	d2	d3	Pris	
9/10	12	3	14	16		
	17					
	22					
	27					
	36					
	46					
12	56	6	18	23		
	17					
	22					
	27					
	36					
14/15	46		20	25		
	56					
	17					
	22					
	27					
16	36		22	27		
	46					
	56					
18/20	17	26	31			
	22					
	27					
	36					
	46					
	56					

d1	L1	K	d2	d3	Pris	
18/20	66	6	26	31		
	76					
22/24	22		30	35		
	27					
	36					
	46					
	56					
	66					
	76					
30/32	86		42	47		
	96					
	27					
	36					
	46					
	56					
40/42	66	54	60			
	76					
	86					
	96					
	116					
	136					
	46					
	56					

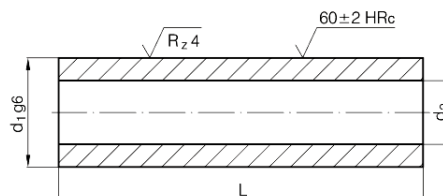

Mat.: 1.7131

Bestillingsnr. 2245 H - d1 x L

d1	L	d2	Pris
10	20	6,2	
	30		
	40		
	50		
	60		
	70		
	80		
	100		
	120		
14	30	8,5	
	40		
	50		
	60		
	70		
	80		
	100		
	120		
	140		
18	40	10,5	
	60		
	80		
	100		

d1	L	d2	Pris
18	120	10,5	
	140		
	160		
	180		
	200		
	220		
	240		
24	60	13	
	80		
	100		
	120		
	140		
	160		
	180		
30	200	17	
	220		
	240		
	80		
	100		
	120		
	140		
	160		
180			

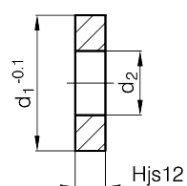

Mat.: 1.7131 60 ± 2HRc

Bestillingsnr. 2245.1 H - d1

d1	d2	H	Pris
14	6,2	3	
18	8,5	4	
24	10,5	5	
30	13,0	6	
40	17,0	8	

POWER TOOLS

KERN TRYKSKIVE OG UDSTØDERBOLT

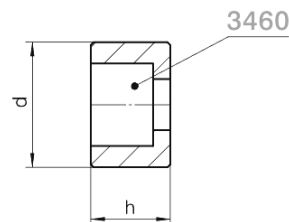

Bestillingsnr. 2246 H - d

Mat.: 1.1191

d	3460	h	Pris
15	M6	10	
22	M8	14	
36	M10	20	
46	M12	25	
56	M16	32	

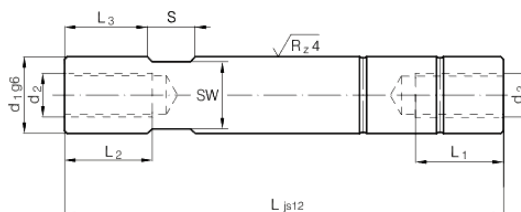

Bestillingsnr. 2246.1 H - d1 x L

Mat.: 1.7131 60 ± 2HRc

d1	L	L1	L2	L3	S	SW	d2	Pris
10	60	10	16	14	8	9	6	
	70							
	80							
	100							
	120							
14	60	17	25	14	8	12	8	
	70							
	80							
	100							
	120							
	140							
	160							
180								
18	70	20	30	16	8	14	10	
	80							
	100							
	120							
	140							
	160							
	180							
	200							
20	80	20	30	16	10	17	12	
	100							

d1	L	L1	L2	L3	S	SW	d2	Pris
20	120	20	30	16	10	17	12	
	140							
	160							
	180							
	200							
	220							
24	70	25	35	22	12	19	12	
	80							
	100							
	120							
	140							
	160							
	180							
	200							
30	180	30	45	28	16	24	16	
	220							
	260							
	300							
	340							
	380							
40	260	35	55	36	10	36	20	
	300							
	340							
	380							

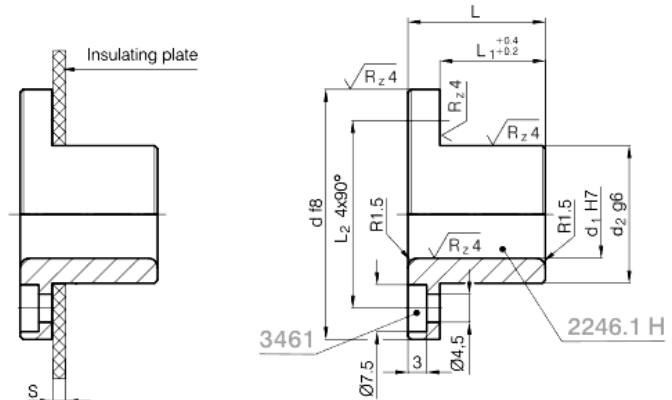
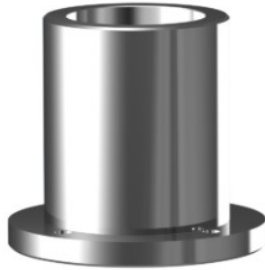

Bestillingsnr. 2247 H - d₁ x L x d

Mat.: 1.7131 60 ± 2HRC

d ₁	L	d	S	L ₁	L ₂	d ₂	Pris		
10	17	40	-	11,9	30	22			
14									
10	22	60		16,9			50	32	
14									
14	17	100		11,9	50	32			
14									
18	27	110		22,0	50	32			
20									
24	36	110		22,0	50	32			
18									

d ₁	L	d	S	L ₁	L ₂	d ₂	Pris		
20	36	110	-	31,0	30	32			
24									
18	27	125		22,0			50	32	
20									
24	36	40		31,0	50	22			
10									
14	29	60		14,9	50	22			
14									
14	20	60		19,9	50	22			
14									
14	25	60	21,9	50	22				
14									

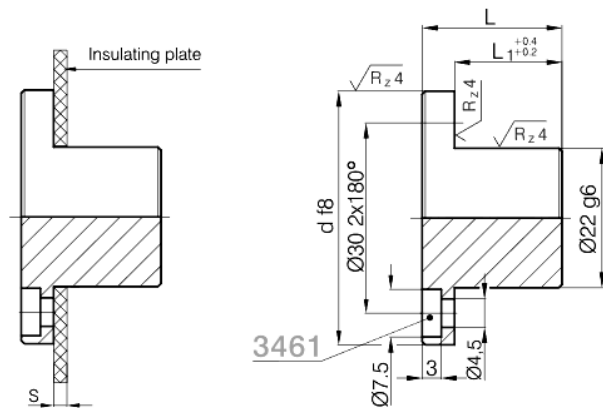

Bestillingsnr. 2248 H - d x L

Mat.: 1.1191 750 N/mm²

d	L	S	L ₁	Pris
40	17	-	12,2	
60				
40	20	3	15,2	
40				
40	22	5	17,2	
40				

d	L	S	L ₁	Pris
60	20	3	15,2	
	22	5	17,2	
	25	3	20,2	
	27	5	22,2	

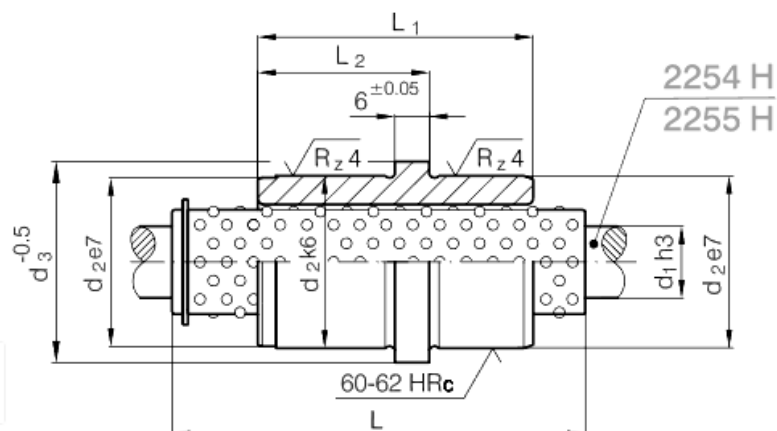

Bestillingsnr. 2250 H - d1 x L

d1	L	L1	L2	Hmax	d3	d2	Pris
12	40	24	18	50	26	22	
	56			82			
18	45	34	23	44	35	30	
	56			66			
	71			96			
30	56	54	33	32	52	46	
	75			70			
	95			110			

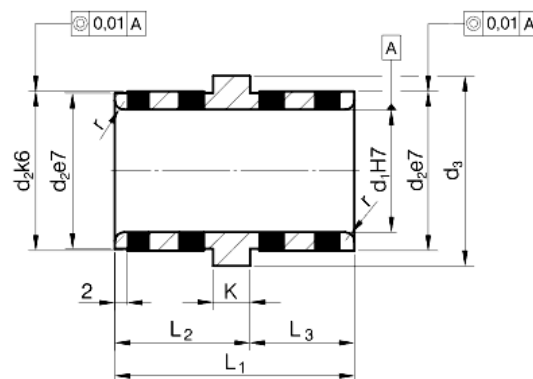

Bestillingsnr. 2252 H - d1 x L2

Mat.: CuZn25Al5Mn4Fe3-C

d1	L2	L1	L3	K	d3	d2	Pris
10	17	26	9	3	16	14	
14				25	20		
18	22	39	17	6	31	26	
30					35	30	
22	27	49	22		47	42	
24							
30							
32	36	63	27				

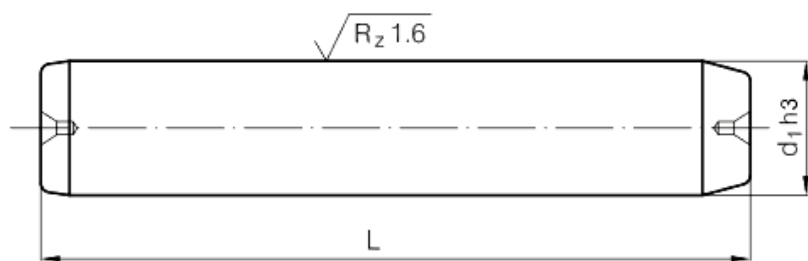

Mat.: 1.7131 60 ± 2HRc



Bestillingsnr. 2254 H - d1 x L

d1	L	Pris
12	100	
	125	
18	125	
	160	
30	160	
	250	

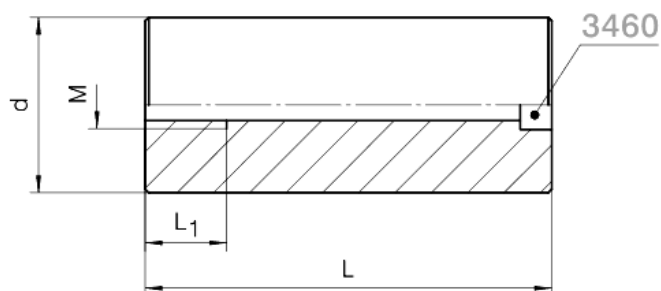

Mat.: 1.1191 750 N/mm²



Bestillingsnr. 2256 H - d x L

d	L	3460	M	L1	Pris
32	46	M6	M8	15	
	56				
	76				
40	46	M8	M10	20	
	56				
	66				
	76				
	86				
	96				
50	116	M8	M10	20	
	46				
	56				
	66				
	76				
	86				
	96				
	116				

d	L	3460	M	L1	Pris
59	136	M8	M10	20	
	56				
66					
76					
86					
96					
116					
136					
156					
80	66				M10
	76				
	86				
	96				
	116				
	136				
	156				
	176				

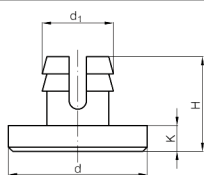

Mat.: 1.7131 60 ± 2HRc



Bestillingsnr. 2257 H - d1

d1	d	H	K	Pris
8	16	11	3	
	25			

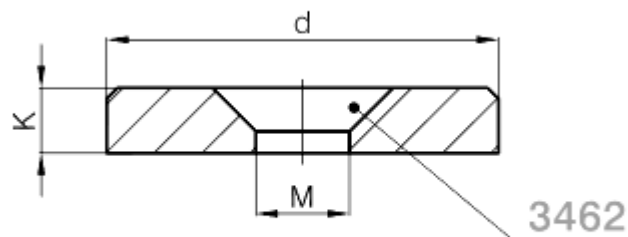
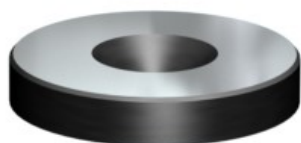

Mat.: 1.1191 750 N/mm²

Bestillingsnr. 2258 H - d

d	M	K	Pris
18	M4	3	
28			
20			
30	M5	4	

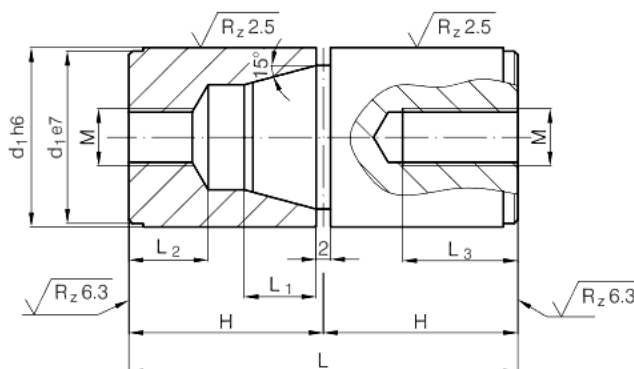
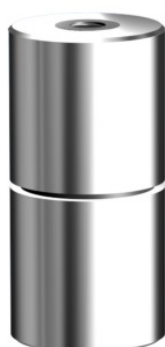

Bestillingsnr. 2260.0 H - d1

Mat.: 1.7131 60 ± 2HRc

d1	L1	L2	M	L3	H	L	Pris
12	4	9	4	10	17	34	
14	6		5				
16	6		5				
20	9	11	8	16	27	54	
25	10						
26	10						
30	14	13	10	20	36	72	
32	14						
42	18				46	92	

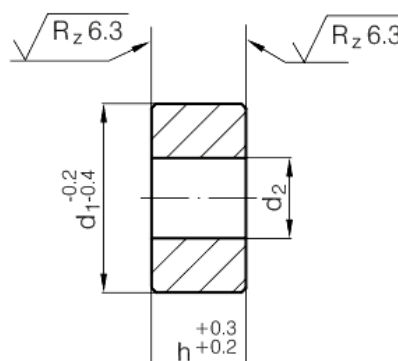

Mat.: 1.7131 60 ± 2HRc

Bestillingsnr. 2260.1 H - h x d1

d1	h	d2	Pris	d1	h	d2	Pris
12	10	4,5		26	10	8,5	
14	5	5,5			20		
	10				30		
	14			30	10	11	
	19				20		
16	5		30				
	10		32	10			
	19			20			
20	9	8,5		42	10		
	10				20		
	20				30		
25	9			54	20	13,5	
	10		40				
	20		80	20	17,5		
9		40					

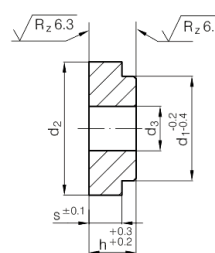

Mat.: 1.7131 60 ± 2HRc

Bestillingsnr. 2260.2 H - d1

d1	h	S	d3	d2	Pris
14	5	3,2	5,5	16,0	
20	9	6,3	8,5	25,5	
26				31,5	
30	10		11,0	35,5	
42				47,5	

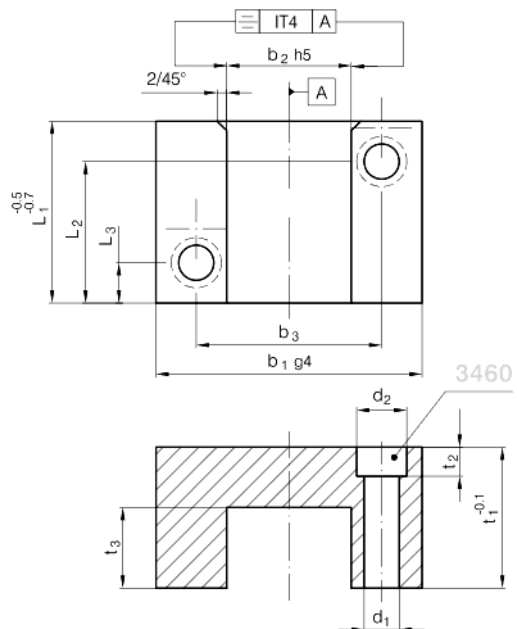

Mat.: 1.7131 60 ± 2HRc

Bestillingsnr. 2262.0 H - L1 x b1

d1	L1	b1	t1	L2	L3	b2	b3	t2	t3	d2	Pris
6,6	22	40	20	15	7	16	26	6,8	12	11	
	27	45	22	19		20	31		14		
	36	50	25	27		25	35		15		
63	63	63	32	35	63	32	45	9	20	15	
85	85	85	36	40	85	40	60	11	23	18	
100	100	100	40	48	100	50	74	13	25	20	

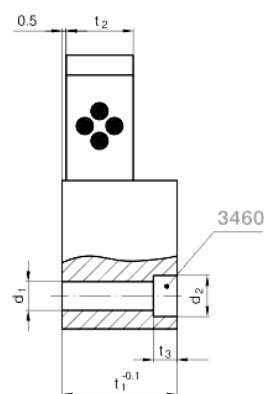
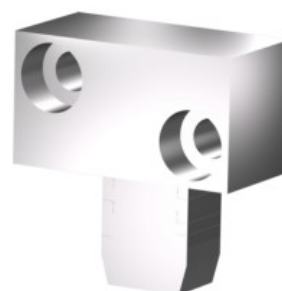
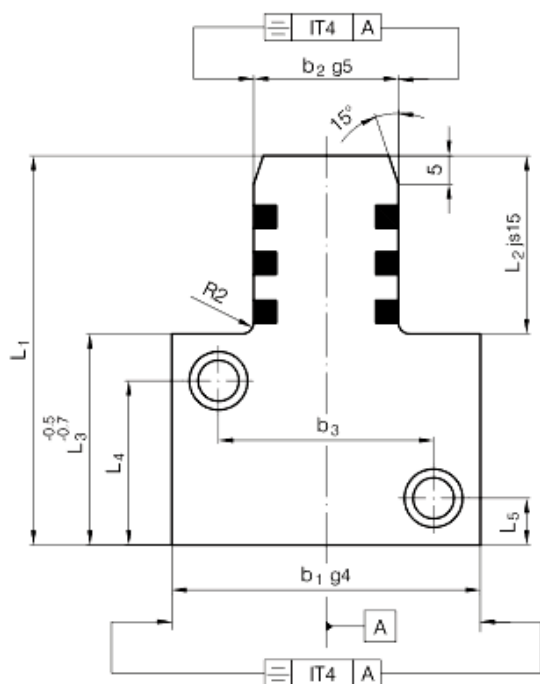

Mat.: 1.7131 60 ± 2Hrc

Bestillingsnr. 2262.1 H - L1 x b1

d1	L1	b1	d2	t3
6,6	42	40	11	6,8
	52	45		
	68	50		
9	86	63	15	8
11	106	85	18	11
14	122	100	20	13
6,6	62	40	11	6,8
	77	45		
	99	50		
9	126	63	15	9
11	156	85	18	11
14	178	100	20	13

t1	L2	L3	L4	b2	b3	t2	L1	b1	Pris
20	20	22	15	7	16	26	11	40	
22	25	27	19		20	31	13	45	
25	32	36	27	9	25	35	14	50	
32	40	46	35	11	32	45	19	63	
36	50	56	40	15	40	60	22	85	
40	56	66	48	18	50	74	24	100	
20	40	22	15	7	16	26	11	40	
22	50	27	19		20	31	13	45	
25	63	36	27	9	25	35	14	50	
32	80	46	35	11	32	45	19	63	
36	100	56	40	15	40	60	22	85	
40	112	66	48	18	50	74	24	100	

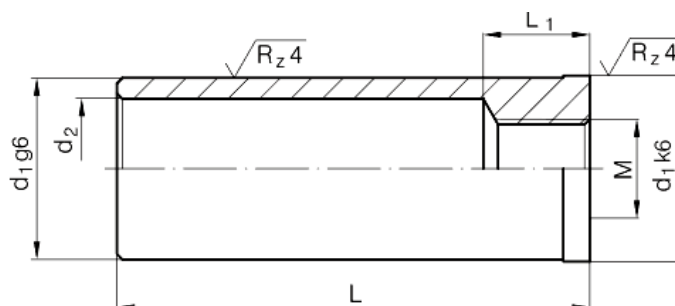

Mat.: 1.7131 60 ± 2HRc

Bestillingsnr. 2265 H - d1 x L

d1	L	M	L1	d2	Pris	d1	L	M	L1	d2	Pris				
14	20	8	8	11		30	60	12	12	25					
	30														
	40														
	50														
	60														
	70														
	80														
	100														
20	30	12	12	16			42				40	16	12	33	
	40														
	50														
	60														
	70														
	80														
	100														
	120														
140															
160															
26	30					21		54	60			43			
	40														
	50														
	60														
	80														
	100														
	120														
	140														
160															
180															
30	40			25			280								

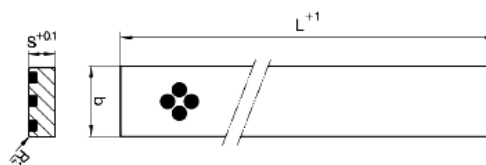

Bestillingsnr. 1281 - b X L x s

b	L	s	Pris
20	305	4	
	605	10	
	1005		
	1005		
25	305	5	
	500		
	605		
	1005		
30	500	6	
	605		
	1005		
	500	8	
	605		
	1005		
	1005		
	605		
35	500	10	
	605		
	1005		
40	500	8	
	605		
	1005		
	500	10	
	605		
	1005		
	500	12	
	605		
	1005		
	500		
50	605	16	
	1005		
	500	8	
	605		
	1005		

b	L	s	Pris
50	605	12	
	1005		
	605	20	
1005			
60	605	8	
	1005		
	605		
	1005	10	
	605		
	1005	12	
	500		
	605		
60	1005	16	
	500		
	605	20	
	1005		
	1005		
75	605	12	
	1005		
80	500		16
	605		
	1005		
	500	20	
	605		
100	1005	10	
	500		
	605	12	
	1005		
	1005		
125	605	16	
	1005		
160	500	20	
	1005		



Form D

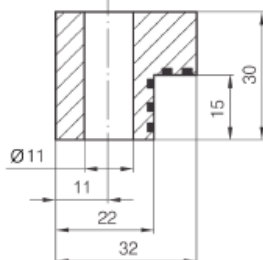

Form F

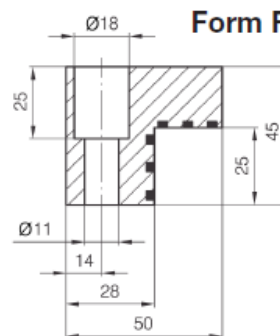

Form H

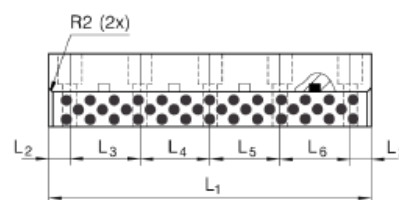
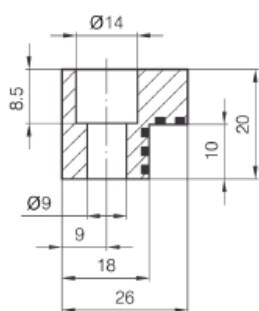
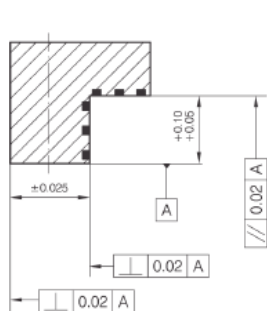

Bestillingsnr. 1282 - Form x L1

L2	L3	L4	L5	L6		Form	L1	Pris	
20	60	-	-	-	2 X M8	H	100		
	55	55	-				3 X M8		150
		50	55				4 X M8		200
	60	-	-		2 X M10	D	100		
	55	55	55				3 X M10		150
		50	55				4 X M10		200
	70	70	70		250				
	55	50	55		F	200			
	70	70	70			250			
	65	65	65			65	300		
80	75	75	80	5 X M10	350				

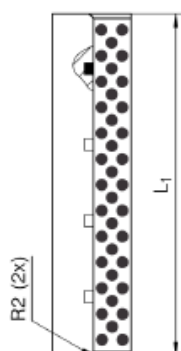

Form A

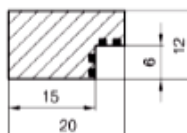

Form B

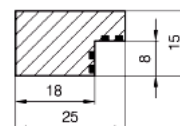

Form C



Form D

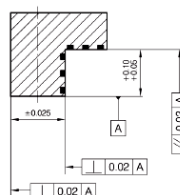

Form E

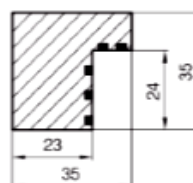

Form G

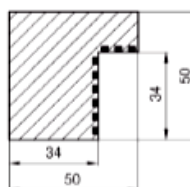

Bestillingsnr. 1283 - Form x L1

Form	L1=500	L1=605	L1=1005	Pris
A	████████	████████	████████	
B	████████	████████	████████	
C	████████	████████	████████	
D	████████	████████	████████	
E	████████	████████	████████	
G	████████	████████	████████	



Form A

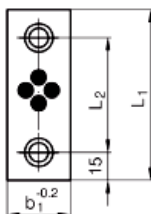

Form C

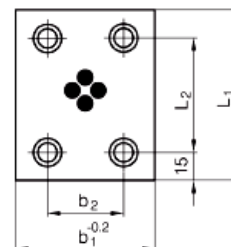

Form B

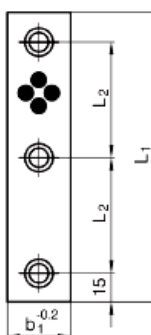

Form D

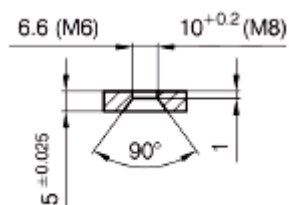
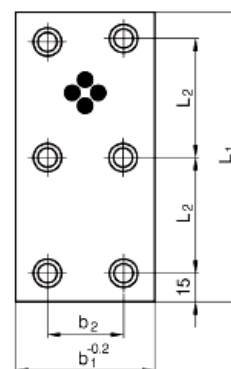

Bestillingsnr. 1284 - Form-B₁ x L₁

L2	Form		b2	b1	L1	Pris			
20	A	M6		18	50				
45					75				
70					100				
60	B				150				
20	A				M8			28	50
45									75
70		100							
60	B	150							
20	A	M8		38					50
45									75
70					100				
60	B				150				
45	A				M8			48	75
70									100
95		125							
60	B	150							
45	C	M8	45	75					75
70									100
95					125				
60	D				150				
70	C				M8		70	100	100
95									125
60		D	150						